



RAM[®]
MOUNTS

Agriculture



About RAM® Mounts

RAM® Mounts manufactures rugged and versatile mounting systems for cameras, tablets and other mobile devices that can be attached nearly anywhere. Unlike other mounts on the market, RAM® allows you to mount items where you need them most. The unique design of the RAM® Mounts system provides quick installation, adjustability, strength, vibration dampening and durability—all at a low cost. Backed by a lifetime warranty, RAM® uses powder-coated marine-grade aluminum with lightweight and high-strength composites, stainless steel hardware and rubber balls.

The RAM® Difference

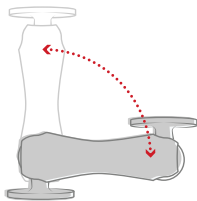

Premium Design

The rubber ball and socket design of our mounting systems offers a secure hold, with near-infinite adjustability and vibration dampening for the most demanding environments. With thousands of components trusted by users around the world, we've been able to design and develop mounting solutions that consumers and companies previously only dreamed were possible.

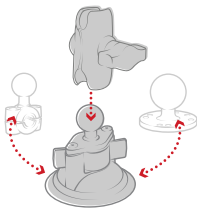

Customizable

Take your phone mount from your truck to your tractor, or mix and match components to create your ideal mount. Because of the modularity of the RAM® system, you can customize your solution to fit your specific needs in almost any application.

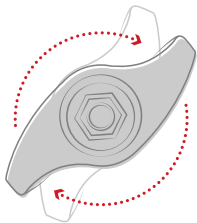

Quality Materials

A premium design deserves the highest quality materials available, from rubber and stainless steel to high-strength composites and marine-grade aluminum. Our facilities—including powder coating, die casting, rubber injection molding, and shock and vibration testing—help us deliver on this promise to bring you inventive mounting solutions.

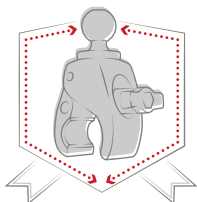

Lifetime Warranty

It's simple. Our reputation as the leader of premier mounting systems means if we build it, then we guarantee it. We're confident in the quality of our products, and with our warranty, you can be too. Learn more rammount.com/warranty about our lifetime warranty.

RAM®'s Presence in the Agriculture Industry

Technological innovation within the agriculture industry has taken off at an unprecedented rate in recent years. What was once a rarity is now commonplace—such as seeing four or five displays in a single cab. While it can be difficult to keep up with technological innovations, RAM® Mounts can help you build for the future.

We've worked closely alongside vehicle and display manufacturers to provide farmers with the best in-cab experience possible. It wasn't always easy to install or adjust the technology being placed in the cab, but we're proud to innovate and help farmers around the world farm more efficiently, effectively and easily.

Depend on RAM® to bring value to your operations with a wide range of mounting solutions built specifically with agriculture in mind.



Popular Mounting Locations

Tractor Cab



- 1,2 | Implement bar supports rail mounts including the RAM® Torque™, RAM® Tough-Claw™ and U-bolt mounts
- 3 | Side window is able to support any RAM® Twist-Lock™ suction cup mount (available in single, double and triple suction)
- 4 | Any flat surface in the tractor cab can accommodate drill-down systems, including double ball mounts or RAM® Tough-Track™
- 5 | Mount any device to the threaded bosses of your cab pillar using the RAM® Tough-Ball™
- 6 | Secure any RAM® Twist-Lock™ suction cup mount to your cab windshield to support any phone, display or sun visor

Popular Mounting Locations

Tractor Cab

1



RAM® Level Cup™ XL, pg. 8
 Socket Arm, pg. 9
 RAM® Torque™ Mount, pg. 10

4



Device Cradles and Adapters, pg. 8
 Socket Arms, pg. 9
 RAM® Track Ball™, pg. 16
 RAM® Tough-Track™, pg. 15

2



RAM® X-Grip® Phone Mount, pg. 7
 Socket Arm, pg. 9
 RAM® Tough-Claw™, pg. 10

5



Device Adapter, pg. 12
 Socket Arm, pg. 13
 Threaded Ball Base, pg. 14

3



Device Adapter, pg. 12
 Socket Arm, pg. 13
 RAM® Twist-Lock™ Suction Cup, pg. 14

6



Sun Visor, pg. 8
 Socket Arm, pg. 9
 RAM® Twist-Lock™ Suction Cup, pg. 10

How It Works

1

Choose a Device Adapter

RAM® offers a wide selection of adapters and cradles for your specific device.

2

Choose an Arm

Select an arm based on your desired length and placement.

3

Choose a Base

Select from a variety of bases to help secure your device where you need it.



Ball Size Selection Guide



B Size

- 1" diameter ball
- Holds up to 2 lbs
- Ideal for phones, cameras and cup holders



C Size

- 1.5" diameter ball
- Holds up to 4 lbs
- Ideal for tablets and small monitors



D Size

- 2.25" diameter ball
- Holds up to 6 lbs
- Ideal for display integrations

Build a Mount

1 | Choose a Device Adapter



RAM-2461U
75mm VESA
Plate Adapter



RAM-202U
4-Hole AMPS Round
Plate Adapter



RAM-270U
Plate Adapter for John Deere
GreenStar 2630 Display



RAM-HOL-UN8BCU
RAM® X-Grip® Holder
for 7"-8" Tablets

2 | Choose an Arm



RAM-201U-B
3.56" Short Socket Arm



RAM-201U
5.69" Medium Socket Arm



RAM-201U-D
9.125" Long Socket Arm

3 | Choose a Base



RAM-235U
.75" to 1.25"
Diameter U-Bolt Base



RAM-202U
4-Hole AMPS
Drill-Down Base



RAP-365-224-1U
RAM® Twist-Lock™ Triple Suction Base



RAM-408-112-15U
1.125" to 1.5" Diameter
RAM® Torque™ Base

B Size Holders & Adapters

The RAM® X-Grip® keeps your phone secure and accessible, no matter what base it's connected to. The spring-loaded design of the RAM® X-Grip® means it can support any size phone with or without a case or sleeve. For use in high vibration environments, the RAM® X-Grip® comes with an easy-to-attach rubber tether for added security. Diamond, rectangular and round adapter plates are also available with the AMPS hole pattern.



RAM-HOL-UN7BU
RAM® X-Grip® Holder
for Phones up to 3.25" Wide



RAM-HOL-UN10BU
RAM® X-Grip® Holder for
Phones up to 4.5" Wide

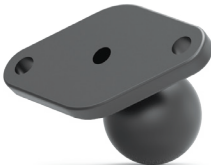

RAM-B-238U
2-Hole AMPS
Diamond Plate
Adapter



RAM-B-347U
4-Hole AMPS
Rectangular Plate
Adapter

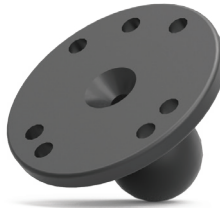

RAM-B-202U
4-Hole AMPS
Round Plate
Adapter



Seen in this photo:
RAP-B-400U,
Small RAM® Tough-Claw™
RAM-B-201U,
Medium Socket Arm
RAM-HOL-UN7BU,
Universal RAM® X-Grip® for Phones

B Size Holders & Adapters

For mounting cameras, the RAP-B-202U-GOP1 is compatible with action cameras featuring a standard two-pronged attachment. For larger cameras with threaded post attachment points, look to the RAP-B-379U-252025 and RAM-B-202AU. As for your drink, both the self-leveling RAM® Level Cup™ and RAM® Level Cup™ XL are available to help you avoid spills. The RAM® Level Cup™ is ideal for cans and small drinks while the RAM® Level Cup™ XL's adjustable height option secures most containers up to 32oz. And to block out the sun, check out our RAM® Dark Green Sun Visor.



RAP-B-202U-GOP1
2-Prong Action
Camera Adapter



RAP-B-379U-252025
1/4"-20 RAM® Tough-Ball™
Camera Adapter



RAM-B-202AU
1/4"-20 Camera Adapter
with Round Plate



RAM-B-132BU
RAM® Level Cup™
Drink Cup Holder
• 12-16 oz. drinks
• Cans
• Small bottles



RAP-B-417BU
RAM® Level Cup™ XL
Drink Cup Holder
• 16-32 oz. drinks
• Tumblers
• Nalgene, Pelican, YETI



RAP-393-G1U
8" x 13" Dark
Green Sun Visor

B Size 1" Socket Arms

RAM® socket arms range from 2.42" to 6" in length and are interchangeable, allowing you to customize your mounting solution. With the RAM® Add-A-Ball™, connect another device to your existing mount with another 1" ball. Connect two arms using the RAM® Double Ball Adapter. For theft deterrence, the RAM® Pin-Lock™ Security Knob replaces the standard knob to offer added security.



RAM-B-201U-A
2.42" Short Socket Arm



RAM-B-201U
3.73" Medium Socket Arm



RAM-B-201U-C
6" Long Socket Arm



RAP-B-200-12U
RAM® Double Socket Swivel Arm



RAP-S-KNOB3U
RAM® Pin-Lock™ Security Knob Accessory



RAM-B-273U
RAM® Add-A-Ball™ Adapter Accessory

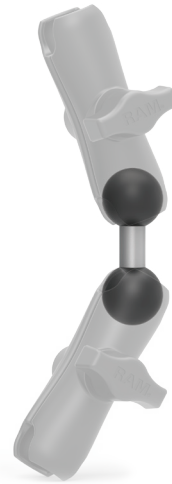

RAM-B-230U
Double Ball Adapter Accessory



Seen in this photo:
 RAM-HOL-AP19, Form-Fit Cradle for the iPhone 6 & 7 Plus
 RAM-B-238U, Diamond Ball Adapter
 RAM-B-201U, Medium Socket Arm
 RAM-B-273U, RAM® Add-A-Ball™ Accessory
 RAM-HOL-AP17U, RAM® EZ-Roll'r™ Cradle for the Apple iPad Air 1-2 & iPad Pro 9.7
 RAM-B-316-1-202U, Universal RAM® No-Drill™
 RAM® Pod™ I Vehicle Mount

B Size 1" Ball Bases

For phones, cameras and cup holders, choose from a range of B size 1" ball bases. For bases featuring AMPS hole patterns, choose between diamond, round and rectangular plates. If you need to mount to a rail, use the RAM® Torque™ — available for various size rails, as well as single and double U-bolt bases. Other options include the popular RAM® Tough-Claw™ for rails and RAM® Twist-Lock™ Suction Cup for non-porous surfaces.



RAM-B-238U
2-Hole AMPS Diamond
Drill-Down Base



RAM-B-202U
4-Hole AMPS Round
Drill-Down Base



RAM-B-347U
4-Hole AMPS Rectangular
Drill-Down Base



RAM-B-408-75-1U
.75" to 1" Diameter
RAM® Torque™ Base



RAM-B-408-112-15U
1.125" to 1.5" Diameter
RAM® Torque™ Base



RAM-B-231ZU
.5" to 1.25" Diameter
Single U-Bolt Base



RAM-B-235U
.75" to 1.25" Diameter
Double U-Bolt Base



RAM-B-404U
1" to 1.875" Diameter
RAM® Tough-Claw™ Base



RAM-B-224-1U
RAM® Twist-Lock™
Single Suction Cup Base



RAM-B-189B-202U
RAM® Twist-Lock™ Double Suction Cup Base

C Size Holders & Adapters

For mounting your tablet, the RAM® X-Grip® is available for tablets ranging from 7" to 12" and phones up to 4.5" wide. For large drinks and containers, the self-leveling RAM® Level Cup™ XL integrates an adjustable height feature to keep your drink in place. Whether you have a Nalgene, Pelican, Contigo or Hydro Flask, the RAM® Level Cup™ XL will secure most 32oz containers.



RAM-HOL-UN7BCU
RAM® X-Grip® Holder for Phones
up to 3.25" Wide



RAM-HOL-UN10BCU
RAM® X-Grip® Holder for Phones
up to 4.5" Wide



RAM-HOL-UN8BCU
RAM® X-Grip® Holder for 7"-8" Tablets



RAM-HOL-UN9U
RAM® X-Grip® Holder for 9"- 10" tablets
Compatible with RAM-202U ball adapter



RAM-HOL-UN11U
RAM® X-Grip® Holder for 11"- 12" tablets
Compatible with RAM-202U ball adapter



RAP-417BU
RAM® Level Cup™ XL Drink Cup Holder

C Size Holders & Adapters

Choose from a variety of adapters to secure your device, including three VESA plate adapters and one specifically for the John Deere GreenStar 2630 Display. Plate adapters with the AMPS hole pattern are available in round, diamond and rectangular versions. For cameras with a threaded post attachment, look to the RAM-202AU, RAM-202CU and RAP-379U-252025.



RAM-2461U
75mm VESA Plate Adapter



RAM-246U
100mm VESA Plate Adapter

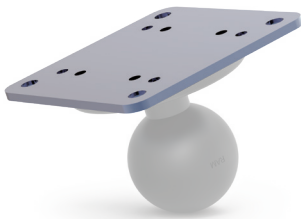

RAM-202-225B-1U
60mm x 60mm VESA Plate Adapter
Note: RAM-202U ball is required



RAM-2462U
35mm x 75mm
VESA Plate Adapter



RAM-270U
Plate Adapter for John Deere
GreenStar 2630 Display



RAM-202U
4-Hole AMPS Round
Plate Adapter



RAM-238U
2-Hole AMPS Diamond
Plate Adapter



RAM-347U
4-Hole AMPS Rectangular
Plate Adapter



RAM-202U-225
2" x 2.5" Rectangular
Plate Adapter
Hole Pattern: 1.5" x 2"



RAM-202AU
1/4"-20 Camera Adapter
with Round Plate



RAM-202CU
3/8"-16 Camera Adapter
with Round Plate



RAP-379U-252025
1/4"-20 RAM® Tough-Ball™
Camera Adapter

C Size 1.5" Socket Arms

Ranging from 3.56" to 9.13" in length, C size 1.5" socket arms are interchangeable and allow you to customize your mounting solution. With the RAP-BC-201U, connect an existing B size ball to a C size ball. With the Double Ball Adapter and Triple Ball Adapter, connect two or three socket arms or mounts. For added security, the RAM® Pin-Lock™ Security Knob replaces the standard knob to offer added security.



RAM-201U-B
3.56" Short Socket Arm



RAM-201U
5.69" Medium Socket Arm



RAM-201U-D
9.13" Long Socket Arm



RAP-BC-201U
B Size to C Size Socket Arm



RAM-230U
Double Ball Adapter Accessory

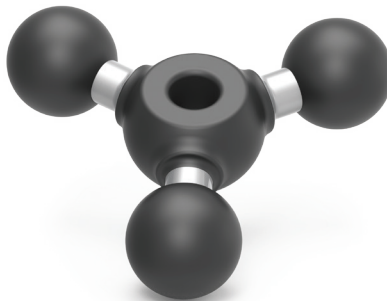

RAM-289U
Triple Ball Adapter Accessory



RAP-S-KNOB5U
RAM® Pin-Lock™ Security Knob Accessory

C Size 1.5" Ball Bases

For tablets and small monitors, the C size 1.5" ball base is a great starting point. Choose from drill-down diamond, round and rectangular plates featuring the AMPS hole pattern that are ideal for tablets and small monitors, as well as U-bolt and RAM® Torque™ bases for rails. The heavy duty RAM® Twist-Lock™ Triple Suction Cup base provides a strong hold to nonporous surfaces, and the RAM® Tough-Ball™ and Threaded Ball are excellent solutions for threaded inserts, if available.



RAM-202U
4-Hole AMPS Round
Drill-Down Base



RAM-347U
4-Hole AMPS Rectangular
Drill-Down Base



RAM-238U
2-Hole AMPS Diamond
Drill-Down Base



RAM-202U-225
2" x 2.5" Rectangular
Drill-Down Base
Hole Pattern: 1.5" x 2"



RAM-111BU
6.25" x 2" Rectangular
Drill-Down Base



RAM-235U
.75" to 1.25" Diameter
U-Bolt Base



RAM-235-1U
1.25" to 1.5" Diameter
U-Bolt Base



RAM-408-75-1U
.75" to 1" Diameter
RAM® Torque™ Base



RAM-408-112-15U
1.125" to 1.5" Diameter
RAM® Torque™ Base



RAP-365-224-1U
RAM® Twist-Lock™
Triple Suction Base



RAP-379U-M812510
RAM® Tough-Ball™
Base for M8-1.25
Threaded Inserts



RAM-349U
Threaded Ball
Base for M10-1.25
Threaded Inserts

RAM® Tough-Track™

A track mounting system provides a clean and innovative way to mount a variety of devices in your cab. With the RAM® Tough-Track™, customize your system with a variety of track lengths and components—available for tubes, rails, and bars as well top-loading composite and modular aluminum versions for flat surfaces. To attach modular aluminum tracks, use the center or 90-degree top-loading connectors.

Top-Loading Composite RAM® Tough-Track™



RAP-TRACK-A5U
Overall length: 7"
Inside Track Length: 5"

RAP-TRACK-A9U
Overall length: 10.75"
Inside Track Length: 9"

RAP-TRACK-A12U
Overall length: 14.5"
Inside Track Length: 12"

RAP-TRACK-A16U
Overall length: 18.5"
Inside Track Length: 16"

Modular Aluminum RAM® Tough-Track™

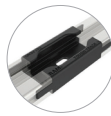

RAM-TRACK-EXA-CCU
Center Top-Loading Connector

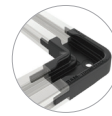

RAM-TRACK-EXA-CC90U
90-Degree Top-Loading Connector

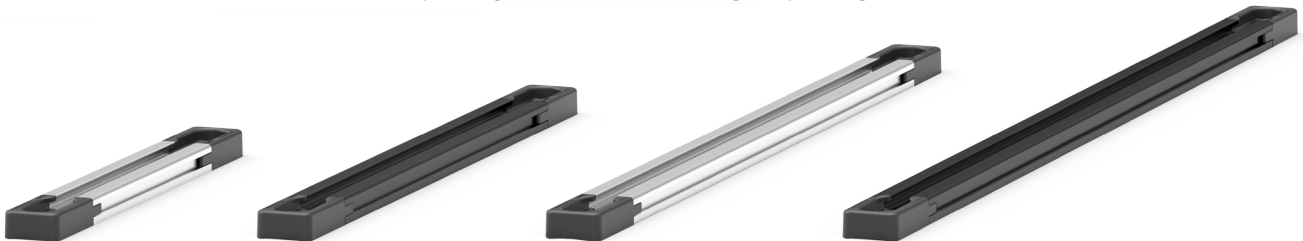

■ Matte Silver Color
Track Length: 5"
RAM-TRACK-EXA-5U

■ Matte Silver Color
Track Length: 9"
RAM-TRACK-EXA-9U

■ Matte Silver Color
Track Length: 13"
RAM-TRACK-EXA-13U

■ Matte Silver Color
Track Length: 17"
RAM-TRACK-EXA-17U

■ Matte Black Color
Track Length: 5"
RAM-TRACK-EXA-5BU

■ Matte Black Color
Track Length: 9"
RAM-TRACK-EXA-9BU

■ Matte Black Color
Track Length: 13"
RAM-TRACK-EXA-13BU

■ Matte Black Color
Track Length: 17"
RAM-TRACK-EXA-17BU

RAM® Tough-Track™ for Rails



RAP-TRACK-B7HU
Rail Diameter Range: 1.75" - 2"
Inside Track Length: 7"

RAP-TRACK-B12U
Rail Diameter Range: 5/8" - 1.25"
Inside Track Length: 12"

RAM® Track Ball™

Designed to be compatible with all track mounting systems, RAM® Track Ball™ bases provide a universal mounting solution for a wide variety of devices. A quick turn of the ball allows the base to slide along tracks, giving you the ultimate flexibility in positioning your gear.



Seen in this photo:
RAM-TRACK-EXA-9U, Modular Aluminum RAM® Tough-Track™
RAP-HOL-UN7B-354-TRA1, RAM® Track Ball™ Mount with Universal RAM® X-Grip®
RAM-B-238U, Diamond Ball Device Adapter
RAM-B-201U, Medium Socket Arm
RAP-B-354U-TRA1, RAM® Track Ball™

D Size 2.25" Ball Adapters

Several D size ball adapters are available for large electronics, including VESA plate adapters. Other adapters include the 2.5" round plate adapter with 4-hole AMPS pattern, the 3.68" round plate and rectangular plates with 4-hole patterns.



RAM-D-254U
2.5" Round Plate Adapter
4-Hole AMPS Hole Pattern



RAM-D-202U
3.68" Round Plate Adapter



RAM-D-202U-24
2" x 4" Rectangular Plate Adapter
1.5" x 3.5" 4-Hole Pattern



RAM-D-202U-25
2" x 5" Rectangular Plate Adapter
1.5" x 4.5" 4-Hole Pattern

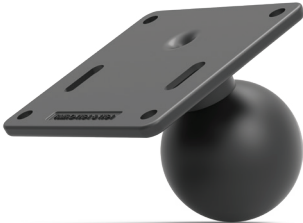

RAM-D-2461U
75mm VESA Plate Adapter



RAM-D-246U
100mm VESA Plate Adapter



RAM-D-2462U
35mm x 75mm VESA Plate Adapter

D Size 2.25" Socket Arms

D size socket arms range from 5.1" to 12.98" in length, and the Double Ball Adapter gives you the ability to connect two socket arms. With the RAM® Hi-Torq™ wrench accessory that matches the socket arm's knob, get the tight hold you desire. For added security, check out the RAM® Pin-Lock™ Security Nut accessory.



RAM-D-201U-C
5.1" Short Socket Arm



RAM-D-201U
8.44" Medium Socket Arm



RAM-D-201U-E
12.98" Long Socket Arm



RAM-D-230U
Double Ball Adapter
Accessory



RAM-KNOB9HU
RAM® Hi-Torq™
Wrench Accessory



RAP-S-NUT5U
RAM® Pin-Lock™
Security Nut Accessory

D Size 2.25" Ball Bases

For display integrations, RAM® offers D size 2.25" ball bases. Choose from the 3.68" round drill-down base, the 2.5" round drill-down base with AMPS hole pattern, rectangular plate adapters with 4-hole patterns and a rectangular drill-down base. For mounting to rails from .75" to 1.5", look to the double U-bolt base.



RAM-D-202U
3.68" Round
Drill-Down Base



RAM-D-254U
2.5" Round Drill-Down Base
4-Hole AMPS Hole Pattern



RAM-D-202U-24
2" x 4" Rectangular Plate Adapter
1.5" x 3.5" 4-Hole Pattern



RAM-D-111BU
3" x 11" Rectangular Drill-Down Base



RAM-D-202U-25
2" x 5" Rectangular Plate Adapter
1.5" x 4.5" 4-Hole Pattern



RAM-D-235U
.75" to 1.25"
Diameter U-Bolt Base



RAM-D-235-1U
1.25" to 1.5"
Diameter U-Bolt Base

IntelliSkin® with GDS®

GDS® Always Protected. Always Connected.™

The IntelliSkin® is a protective sleeve that features an integrated power connector compatible with any GDS® charging dock, allowing for seamless integration from your tractor to your vehicle. This innovative solution prevents damage to the device charging port and creates a universal docking platform compatible with any device wrapped with an IntelliSkin®. IntelliSkin® adds functionality by simplifying the frequent docking and undocking of smartphones and tablets.



The distinctive "D" product shape of the GDS® connector is a trademark of National Products Inc.



Peripherals



GDS® View™



GDS® Keyboard™



GDS® Audio™



GDS® Hub™



GDS® Charge™

Think Outside The Tractor Cab

From ATVs and UTVs to work trucks, you can find RAM® everywhere in the agriculture industry and anywhere on the farm. Our interchangeable mounting solutions are the most versatile of their kind—move almost any mount from one vehicle with a base and arm to another vehicle with a base and arm—meaning you can scale without spending money on an entirely new system.

You can always feel confident knowing that RAM® Mounts are backed by a lifetime warranty. We believe in the product so much that we're confident it can support nearly any mounting need you have. If you have a custom mounting need, get in touch with our agriculture mounting experts at sales@rammount.com.



Partner Highlight Section

Here at RAM® Mounts, we believe that unfathomable things are possible with ingenuity. With a portfolio of more than 5,000 SKUs paired with innovative engineers and product experts in-house, we have the tools and expertise needed to create solutions that you didn't know were possible. We have the ability to solve your mounting challenges quickly, efficiently and cost effectively.

No matter your company's size, you can trust RAM® Mounts to deliver ingenious solutions that do exactly what you need them to do.



JOHN DEERE



Drawings

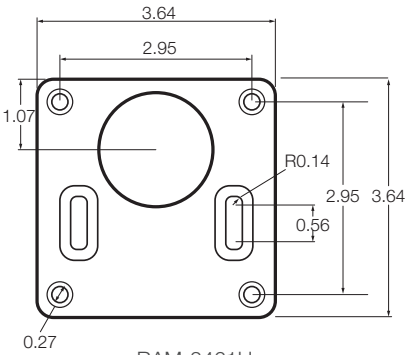

RAM-2461U
RAM-D-2461U

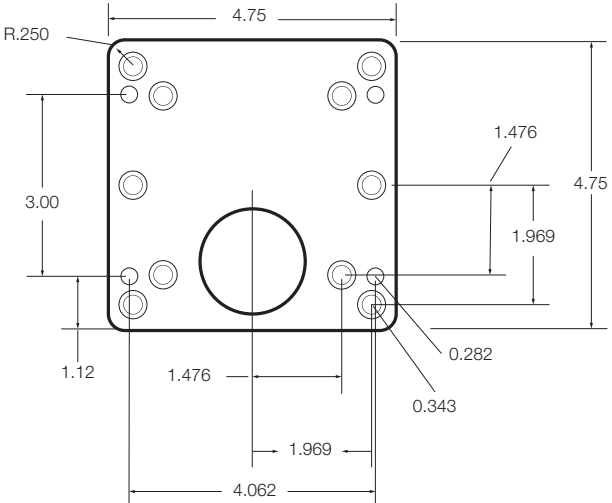

RAM-246U
RAM-D-246U

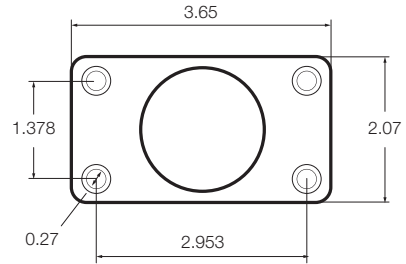

RAM-2462U
RAM-D-2462U

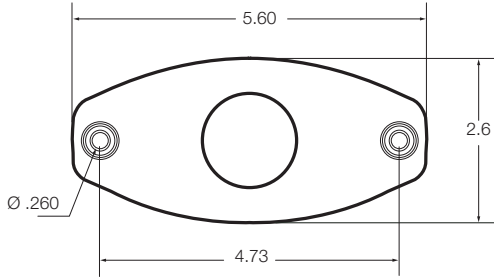

RAM-270U

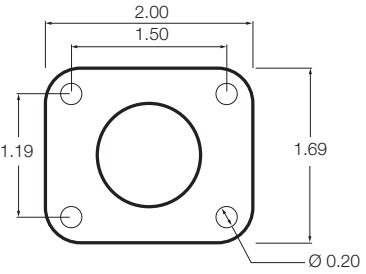

RAM-B-347U
RAM-347U

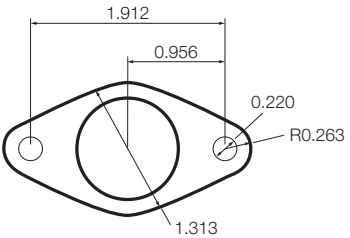

RAM-B-238U
RAM-238U

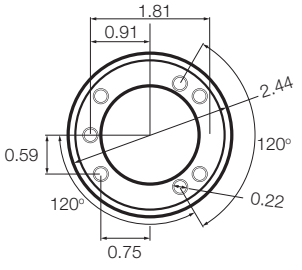

RAM-B-202U
RAM-202U

Drawings

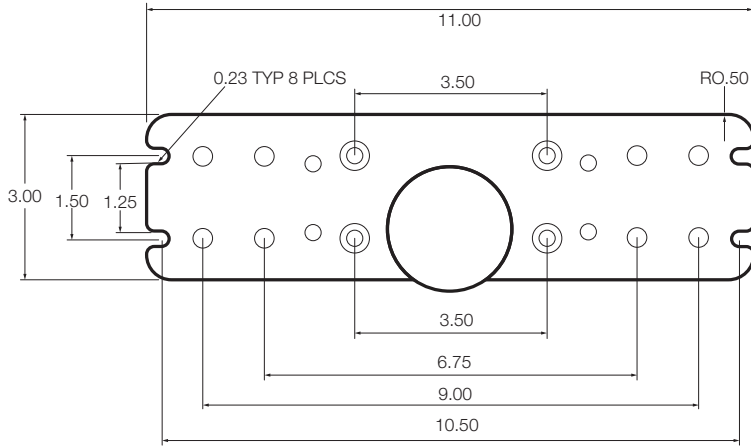

RAM-D-111BU

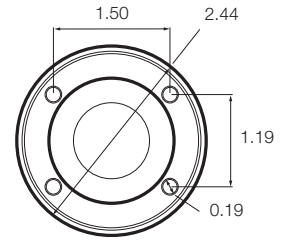

RAM-D-254U

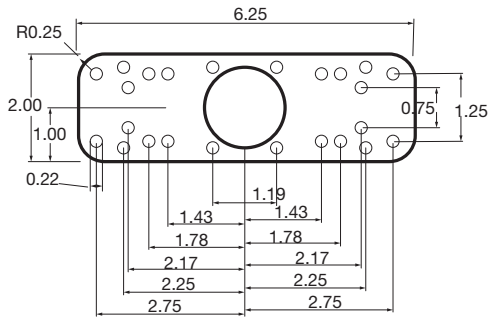

RAM-111BU

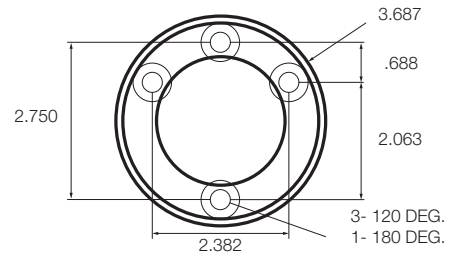

RAM-D-202U

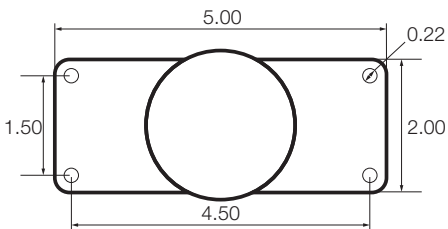

RAM-D-202U-25
RAM-202U-25

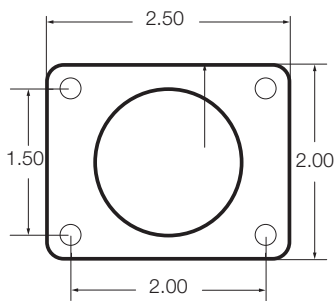

RAM-202U-225

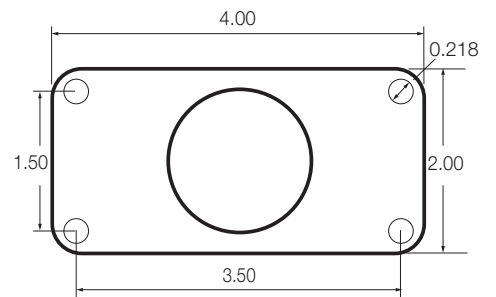

RAM-D-202U-24
RAM-202U-24

New Products

RAM® Tough-Track™ for Rails



RAP-TRACK-B7U
Rail Diameter Range: 5/8" - 1.25"
Inside Track Length: 7"



RAP-TRACK-B12U
Rail Diameter Range: 5/8" - 1.25"
Inside Track Length: 12"



RAP-TRACK-B18U
Rail Diameter Range: 5/8" - 1.25"
Inside Track Length: 18"



RAP-TRACK-B7HU
Rail Diameter Range: 1.75" - 2"
Inside Track Length: 7"



RAP-TRACK-B12HU
Rail Diameter Range: 1.75" - 2"
Inside Track Length: 12"



RAP-TRACK-B18HU
Rail Diameter Range: 1.75" - 2"
Inside Track Length: 18"

RAM® Tough-Track™ with RAM® Tough-Claw™



RAP-400-TRACKU
RAM® Tough-Claw™ Size: **SMALL**
Rail Diameter Range: 0.625" - 1.5"



RAP-404-TRACKU
RAM® Tough-Claw™ Size: **MEDIUM**
Rail Diameter Range: 1" - 1.875"



RAP-401-TRACKU
RAM® Tough-Claw™ Size: **LARGE**
Rail Diameter Range: 1" - 2.25"

The Shape That Started It All

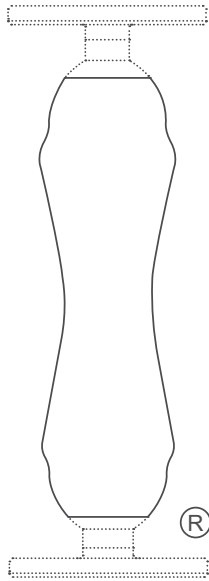

RAM® double socket arms with their distinctive Hourglass Shape are recognized globally as a symbol of the reliability, quality and durability of this line of products. The Hourglass Shape is a registered trademark of National Products Inc.

The unique RAM® Mounts system offers a full line of interchangeable mounting bases, extensions, device adapters and accessories to secure your gear where you want it. See all of the innovative products and solutions RAM® manufactures at rammount.com.



The distinctive "X-Grip" product shape is a trademark of National Products Inc.



The distinctive "D" product shape of the GDS® connector is a trademark of National Products Inc.

RAM® Mounts is a division of National Products Inc.
8410 Dallas Avenue South
Seattle, WA 98108
Phone: 800.497.7479
sales@rammount.com
rammount.com

Lifetime Warranty
Patents and Trademarks
rammount.com/ip

Contact Us
sales@rammount.com
1-800-497-7479



Join Our Community

